

Ethernet



Network Fundamentals

Characteristics of Network Media used in Ethernet

- Identify several characteristics of Ethernet in its early years.

Early Ethernet Media and Topology

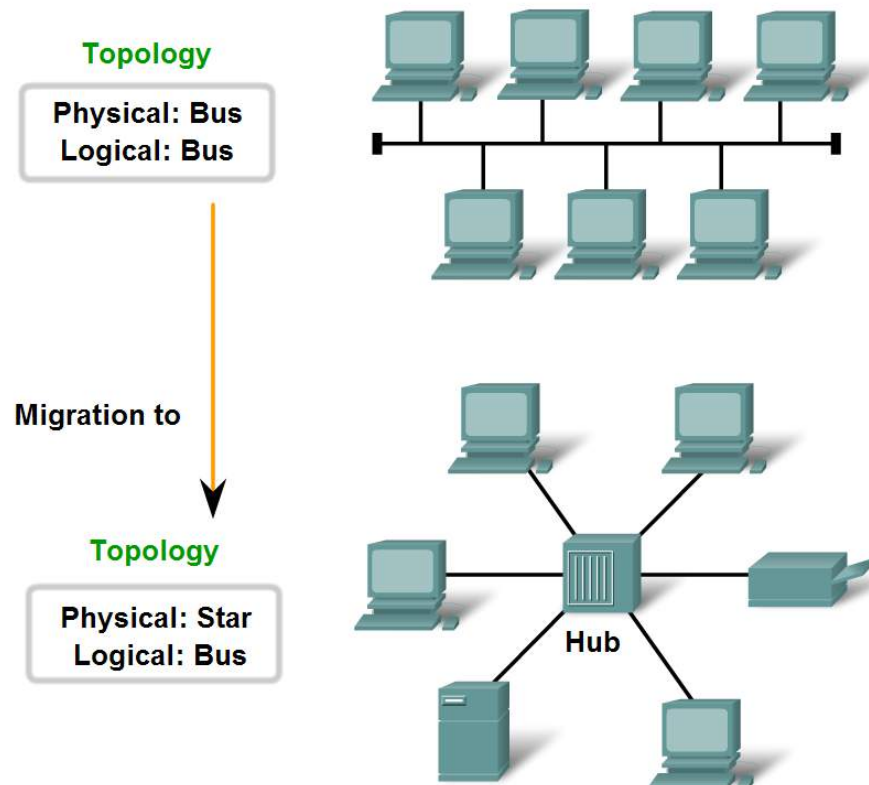

Characteristics of Network Media used in Ethernet

- Describe the emergence of the LAN switch as a key innovation for managing collisions on Ethernet-based networks

Migration to Ethernet Switches

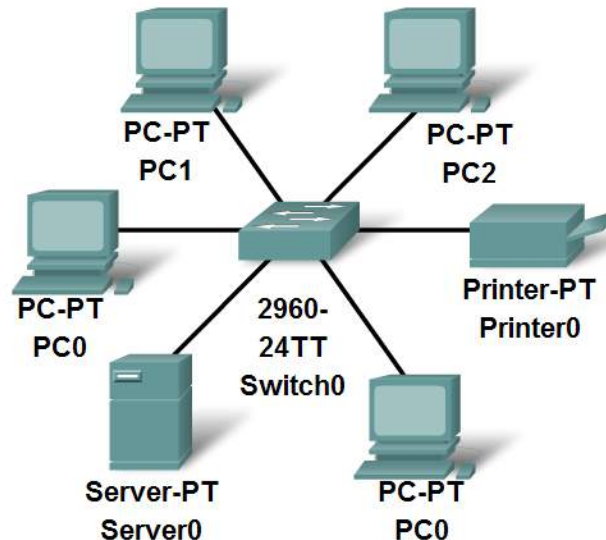

Characteristics of Network Media used in Ethernet

- Identify the characteristics of state-of-the-art Ethernet and describe its utilization of cabling and point-to-point topography

Gigabit Ethernet

Gigabit Ethernet technology is applied beyond the enterprise LAN to MAN and WAN-based networks.

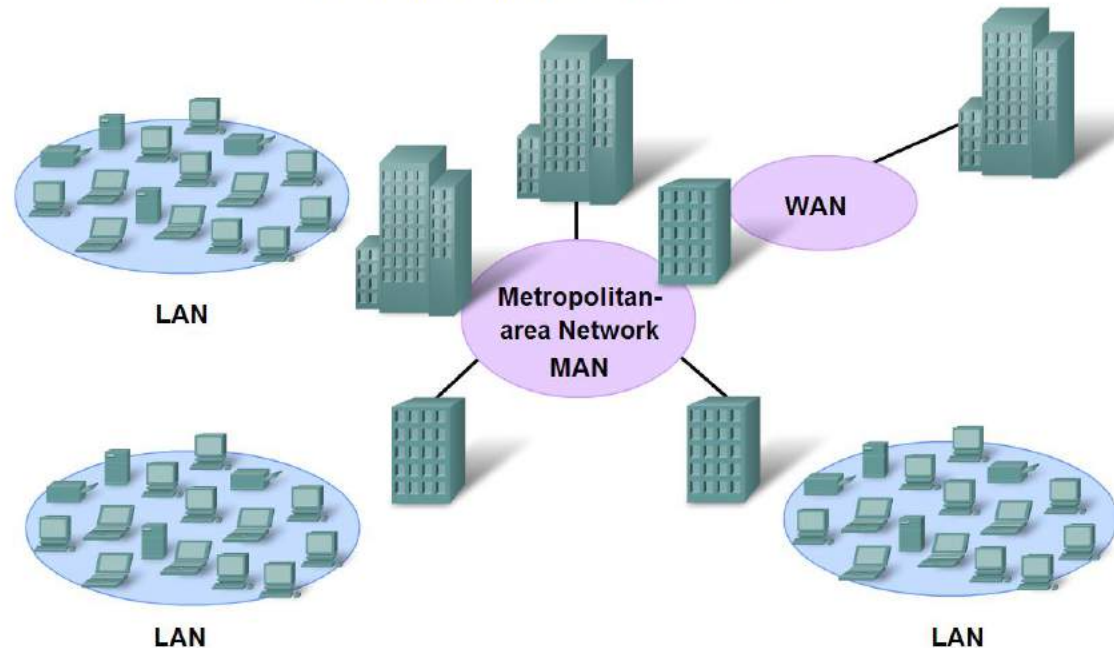

Physical and Data Link Features of Ethernet

- Standards and Implementation

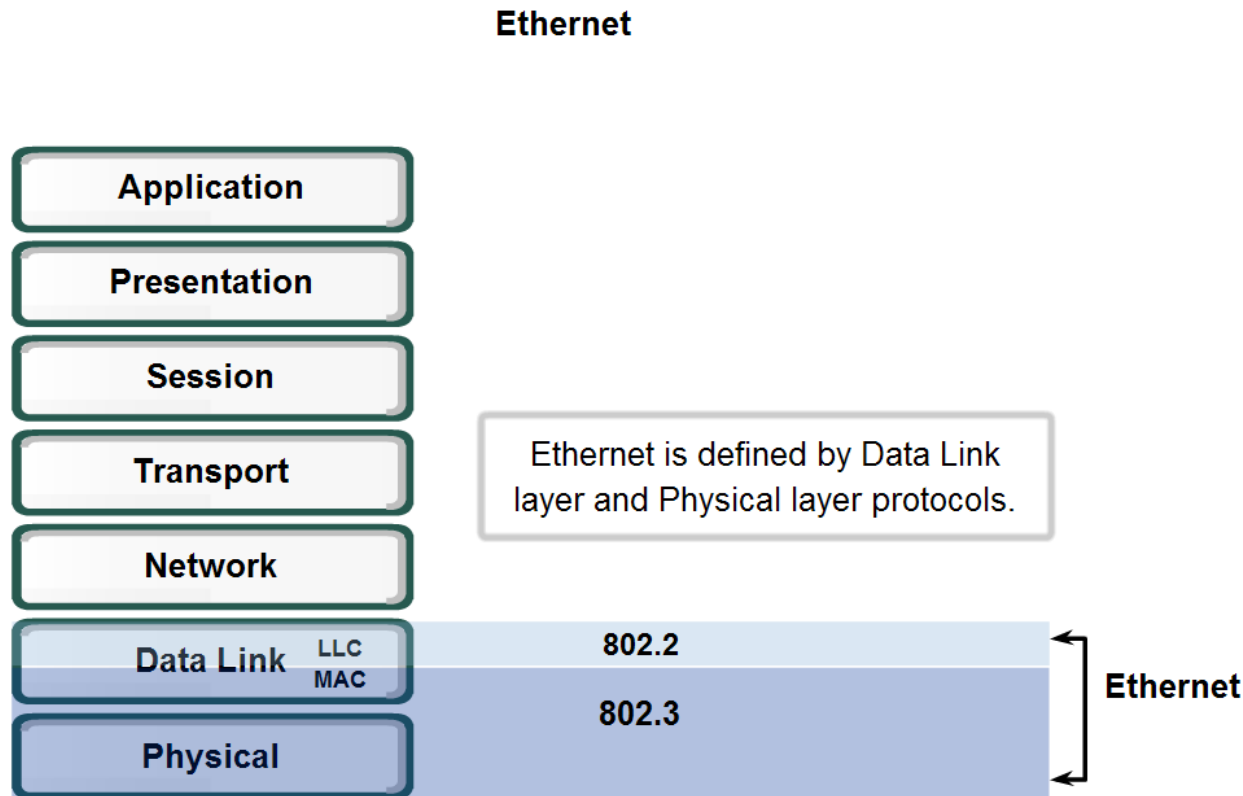

Physical and Data Link Features of Ethernet

- Describe how the Ethernet operates across two layers of the OSI model

Layer 2 Addresses Layer 1 Limitations

Layer 1 Limitations	Layer 2 Functions
Cannot communicate with upper layers	Connects to upper layers via Logical Link Control (LLC)
Cannot identify devices	Uses addressing schemes to identify devices
Only recognizes streams of bits	Uses frames to organize bits into groups
Cannot determine the source of a transmission when multiple devices are transmitting	Uses Media Access Control (MAC) to identify transmission sources

Physical and Data Link Features of Ethernet

- Logic Link Control – Connecting the Upper Layers

Logical Link Control (LLC)

- Makes the connection with the upper layers
- Frames the Network layer packet
- Identifies the Network layer protocol
- Remains relatively independent of the physical equipment

Logical Link Control Sublayer	
802.3 Media Access Control	
Physical Signaling Sublayer	Physical Medium
10BASE5 (500m) 50 Ohm Coax N-Style	10BASE2 (185m) 50 Ohm Coax BNC
10BASE-T (100m) 100 Ohm UTP RJ-45	100BASE-TX (100m) 100 Ohm UTP RJ-45
100BASE-CX (25m) 150 Ohm STP mini-DB-9	1000BASE-T (100m) 100 Ohm UTP RJ-45
1000BASE-SX (220-550m) MM Fiber SC	1000BASE-LX (550-5000m) MM or SM Fiber SC

Physical and Data Link Features of Ethernet

- Media Access Control (MAC)

MAC—Getting Data to the Media

MEDIA ACCESS CONTROL

- **Data Encapsulation**
 - Frame delimiting
 - Addressing
 - Error detection
- **Media Access Control**
 - Control of frame placement on and off the media
 - media recovery

Physical and Data Link Features of Ethernet

- Physical Implementations of the Ethernet

Physical Devices Implementing Ethernet

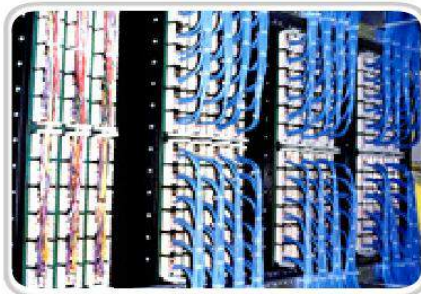

UTP patch panels in a rack



Ethernet switches

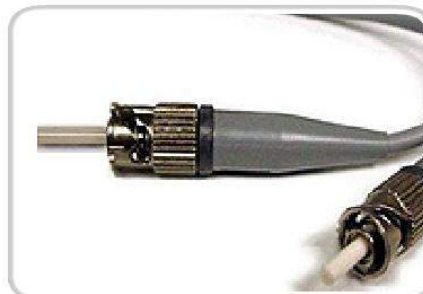

Ethernet fiber connectors



Ethernet switch

Function and Characteristics of the Media Access Control Method

- MAC in Ethernet

Media Access Control in Ethernet

Carrier Sense Multiple Access with Collision Detection (CSMA/CD)

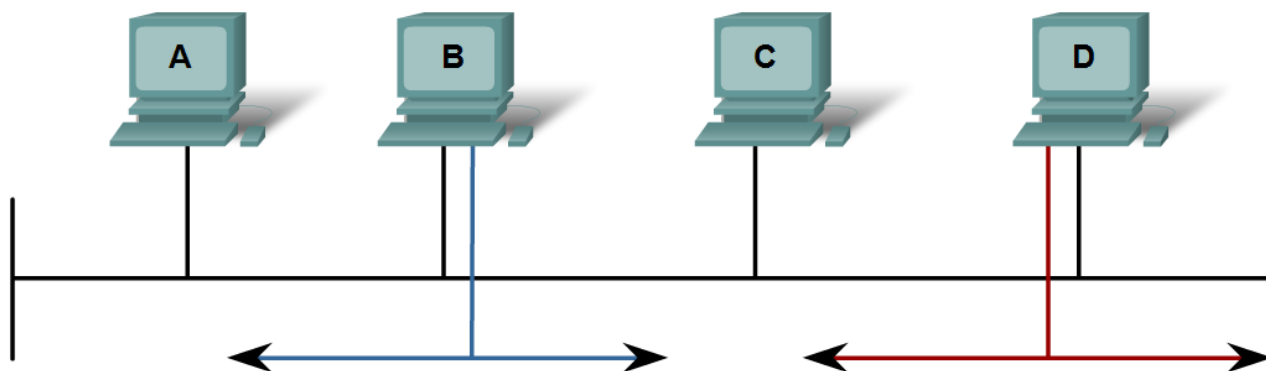

CSMA/CD controls access to the shared media. If there is a collision, it is detected and frames are retransmitted.

Function and Characteristics of the Media Access Control Method

- Carrier Sense Multiple Access with Collision Detection

Media Access Control in Ethernet

Carrier Sense Multiple Access with Collision Detection (CSMA/CD)

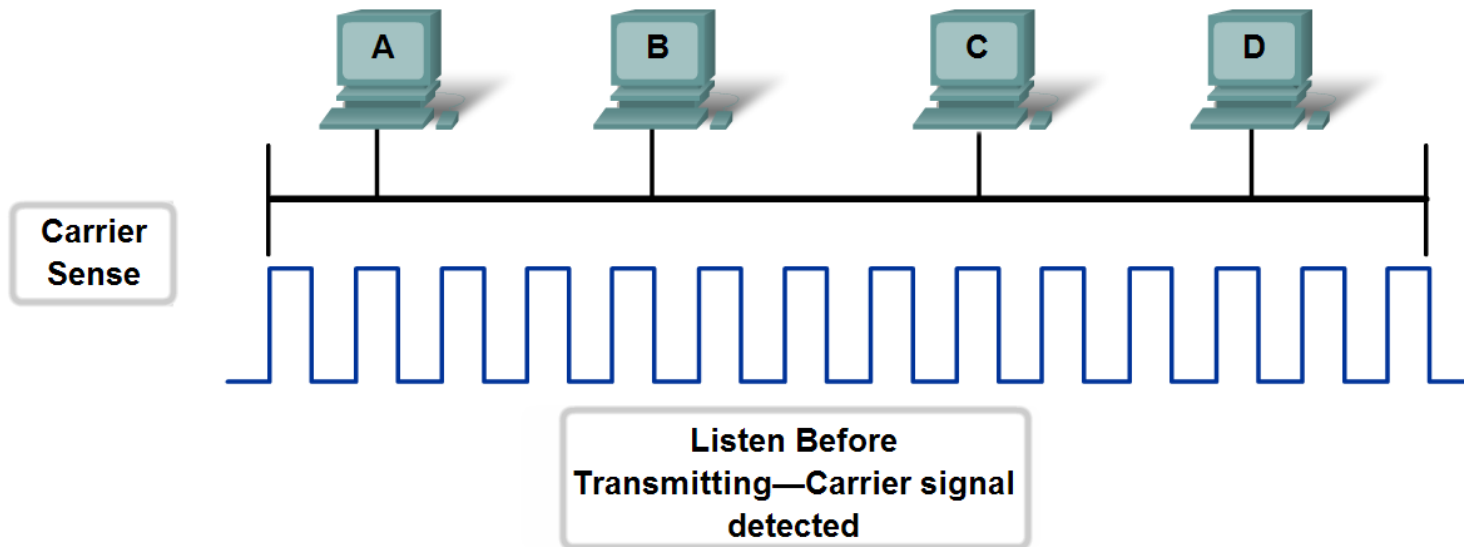

Function and Characteristics of the Media Access Control Method

- Ethernet Timing

Ethernet Delay (Latency)

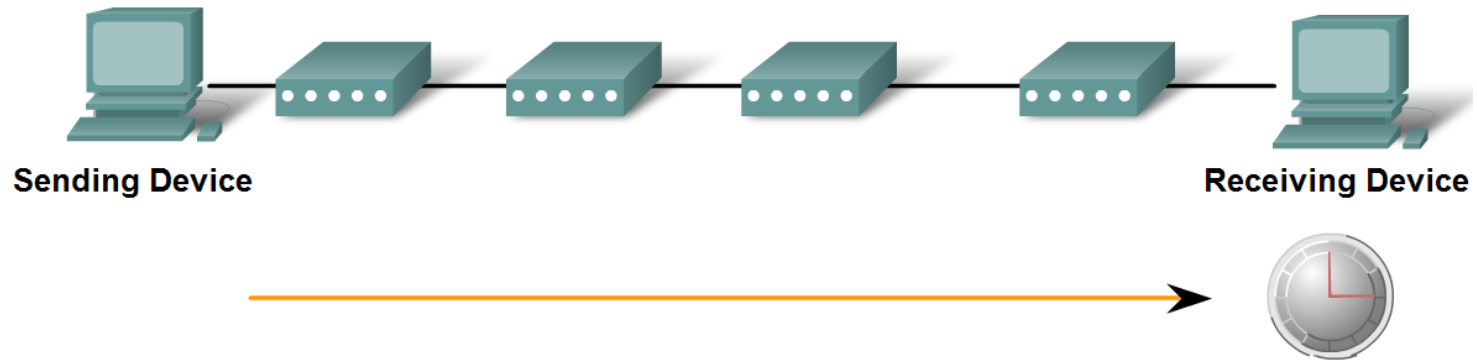

An Ethernet frame takes a measurable time to travel from the sending device to the receiver. Each intermediary device contributes to the overall latency.

Layer 2 addressing and its Impact on Network Operation and Performance

- The Frame – Encapsulating the Packet

Comparison of 802.3 and Ethernet Frame Structures and Field Size

Field size in bytes

IEEE 802.3						
7	1	6	6	2	46 to 1500	4
Preamble	Start of Frame delimiter	Destination Address	Source Address	Length/Type	802.2 Header and Data	Frame Check Sequence

Ethernet					
8	6	6	2	46 to 1500	4
Preamble	Destination Address	Source Address	Type	Data	Frame Check Sequence

Layer 2 addressing and its Impact on Network Operation and Performance

- The Ethernet MAC Address

The MAC Address—Addressing in Ethernet

All Ethernet nodes share the media.
To receive the data sent to it, each node needs a unique address.

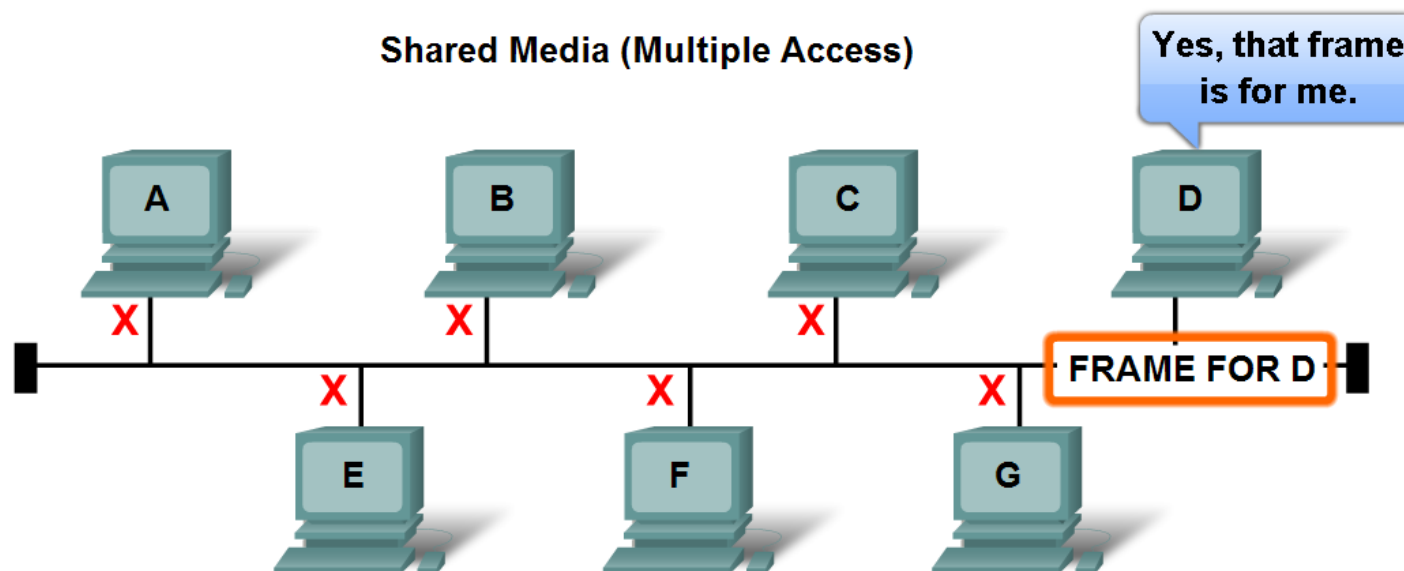

Layer 2 addressing and its Impact on Network Operation and Performance

- Hexadecimal Numbering and Addressing

Hexadecimal Numbering

Decimal and Binary equivalents of 0 to F
Hexadecimal

Decimal	Binary	Hexadecimal
0	0000	0
1	0001	1
2	0010	2
3	0011	3
4	0100	4
5	0101	5
6	0110	6
7	0111	7
8	1000	8
9	1001	9
10	1010	A
11	1011	B
12	1100	C
13	1101	D
14	1110	E
15	1111	F

Selected Decimal, Binary and Hexadecimal
equivalents

Decimal	Binary	Hexadecimal
0	0000 0000	00
1	0000 0001	01
2	0000 0010	02
3	0000 0011	03
4	0000 0100	04
5	0000 0101	05
6	0000 0110	06
7	0000 0111	07
8	0000 1000	08
10	0000 1010	0A
15	0000 1111	0F
16	0001 0000	10
32	0010 0000	20
64	0100 0000	40
128	1000 0000	80
192	1100 0000	C0
202	1100 1010	CA
240	1111 0000	F0
255	1111 1111	FF